











NOTA: Para facilitar el montaje, se recomienda montar los Módulos en posición horizontal, encima de una moqueta o similar.

L		4
S		4
R		2
T		12
D		2
F		8
J		2
Y		1
Z		8
X		20
G		4

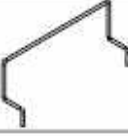

- 2° 1° Pegar en Fieltro (X) al Fondo por la cara inferior.
- 2° Colocar el fondo en el Canapé.
- 3° Ocultar Tornillos con las Pegatinas (G)

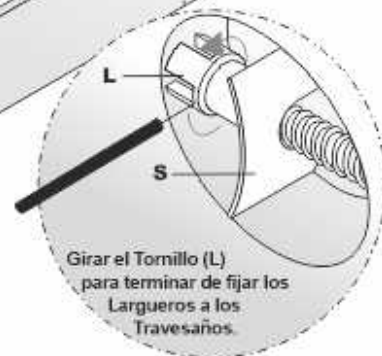
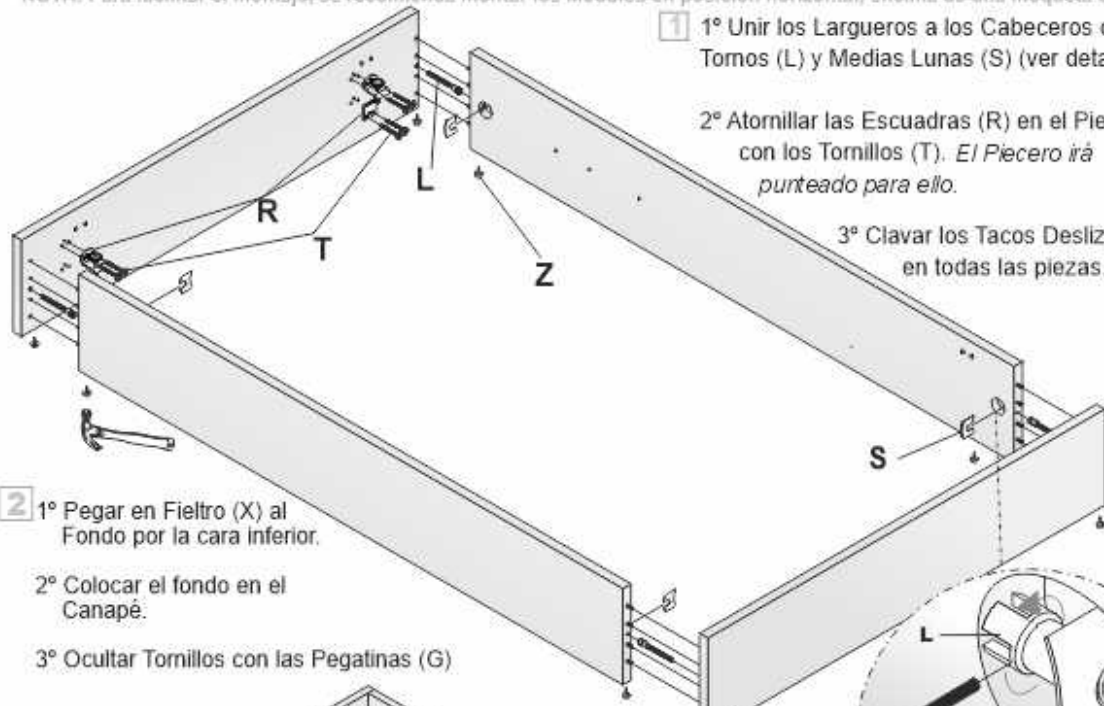
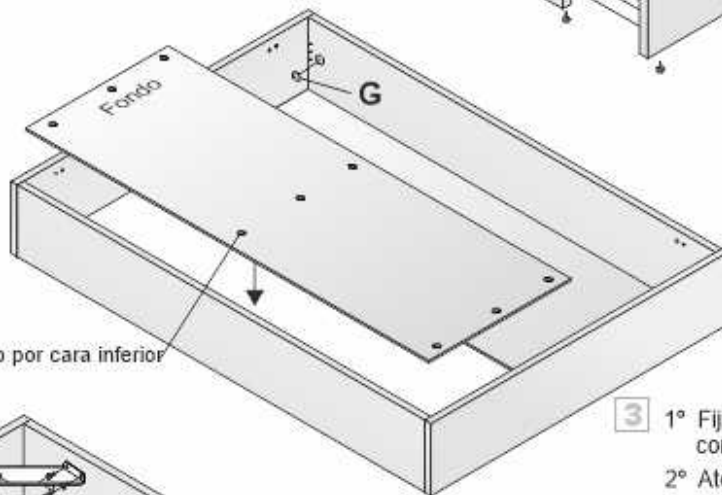

- 3° 1° Fijar las escuadras (D) en el canapé, con los tornillos (F).
- 2° Atornillar el Juego de Compases Hidráulicos (J).

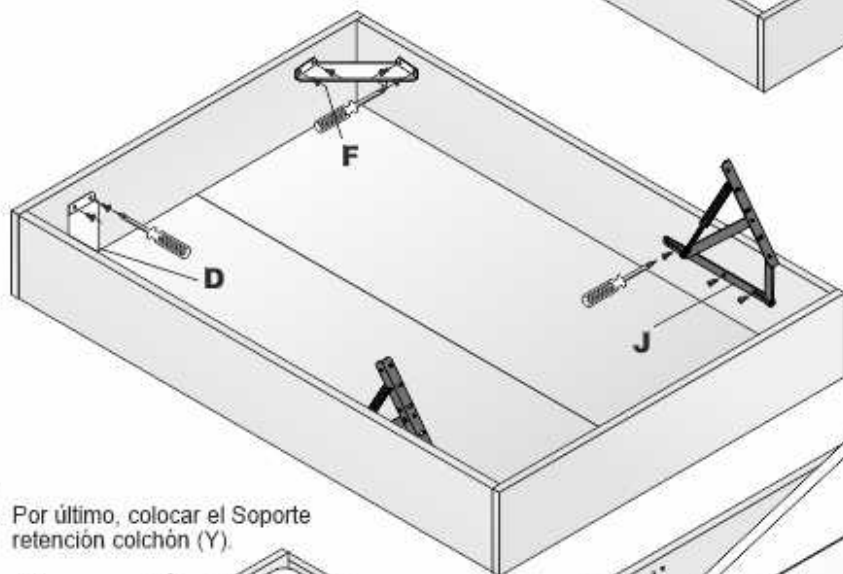

- 4° Atornillar Base Tapizada al Juego de Compases Hidráulicos (J)

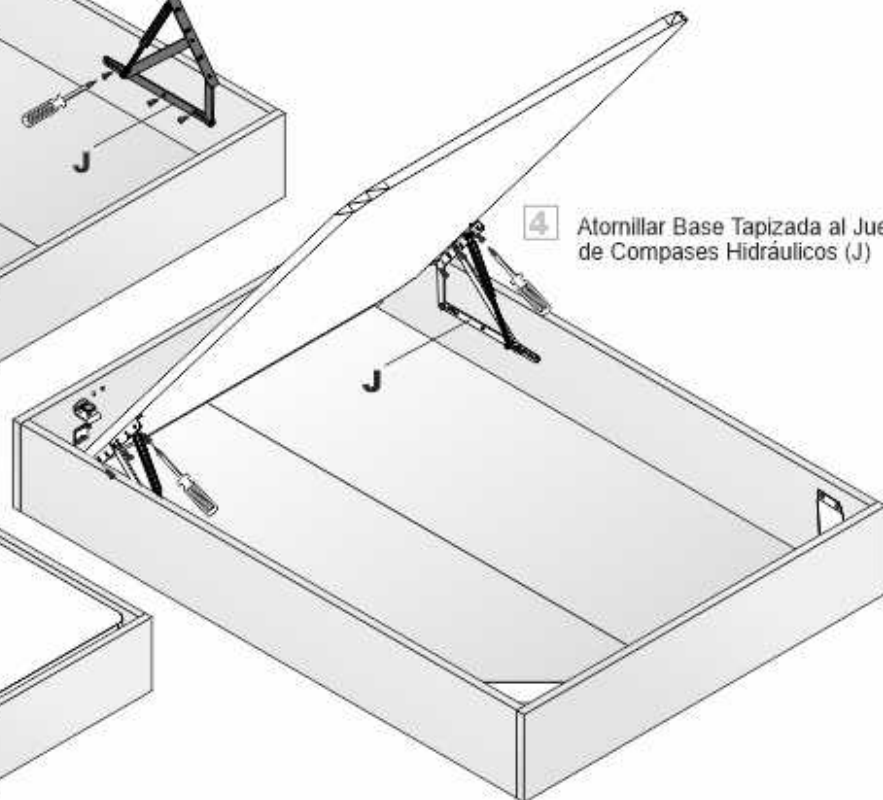

- 5° Por último, colocar el Soporte retención colchón (Y).

